

Technical Specification

D-value	152kN						
94/20 Approval No	e11*94/20*5557						
Imposed Load (U)	20000kg						
Heights mm <i>(all with DIN/ISO mounting pattern)</i>	138*	148	161	185	210	230	257
Weight kg	122	120	122	124	129	134	137

*Please note that the 138mm height is currently rated at U - 18000kg, D-value - 135kN

Fontaine reserves the to change specifications without notice.

Handle options

Fontaine fifthwheels can be user-specified with a range of handle options



Standard handle



Extended handle option

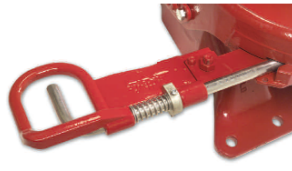

Interlock handle option

Mounting options

A wide range of mounting options is available, ensuring that Fontaine fifthwheels will fit any European chassis and suit any application



DIN mount and mounting plate



Angle mount

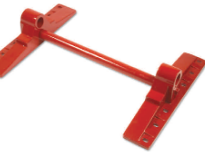

Direct mount

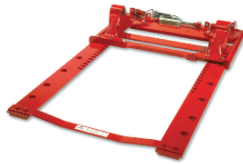

Slider



MHT-Europe • Enterprise Way • Newton Road • Louton • WA3 2AG • United Kingdom
Tel: +44 (0) 1942 686000 • Fax: +44 (0) 1942 686006 • E-mail: sales@fontaineurope.com

3000LM

2" cast low maintenance fifth wheel



3000LM low maintenance cast fifthwheel

the TechLock® system



Global support



The TechLock® system also protects the jaw from high coupling

Low-maintenance replaceable top plates and bearing liners

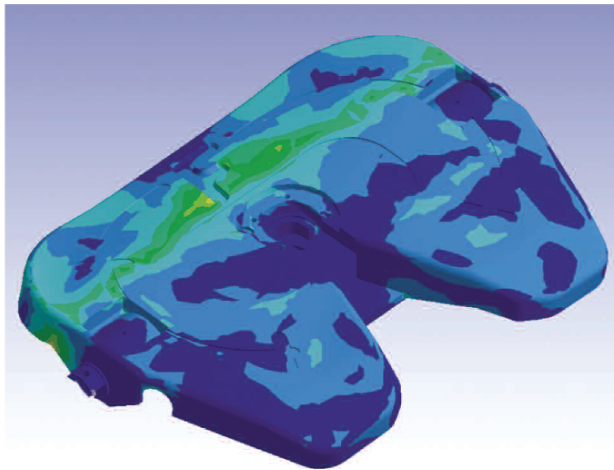
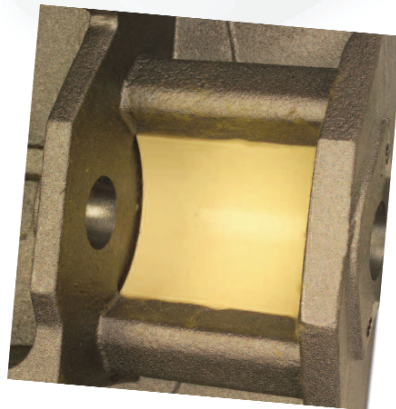

Designed with Finite Element Analysis for low weight and high strength

WARRANTY - Full two-year warranty on parts and labour for all on-road applications

Fontaine's patented kingpin height sensor is at the heart of the TechLock® system. The mechanism will only lock when the kingpin enters at the correct height.

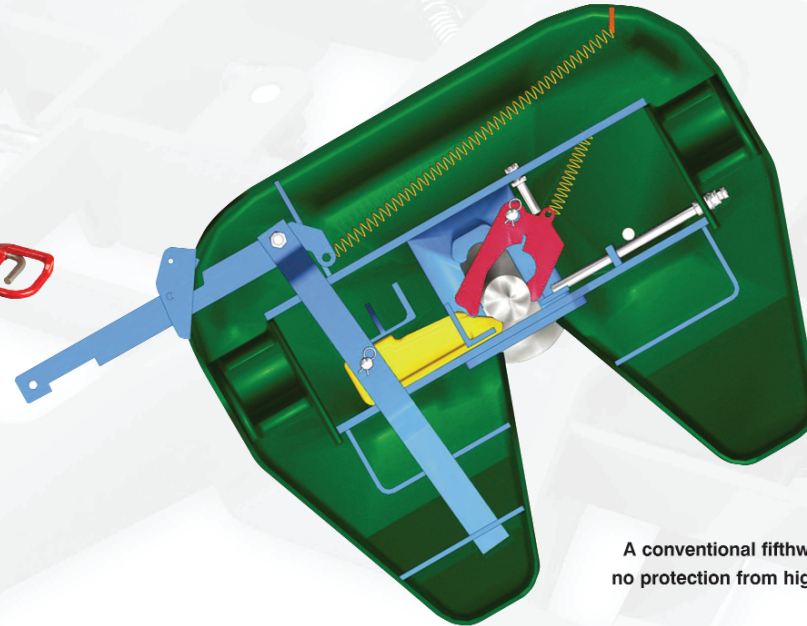
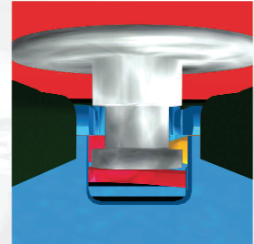

A conventional fifthwheel offers no protection from high coupling

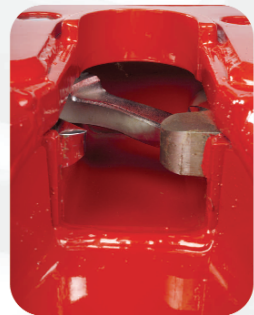

Patented TechLock® system with integral kingpin height sensor prevents false coupling



Up to 58% more contact area for greater durability.

No contact - no couple

